

# SILLS

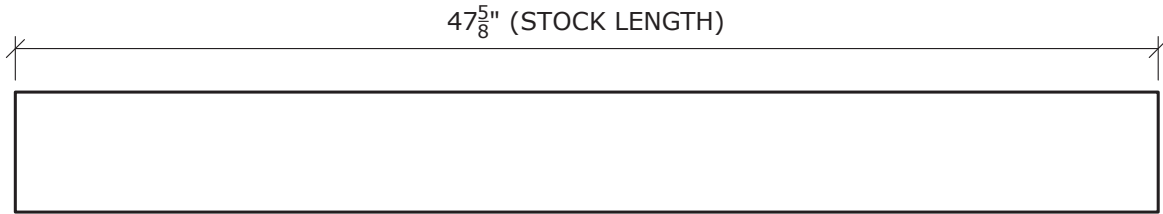

· PLAN ·

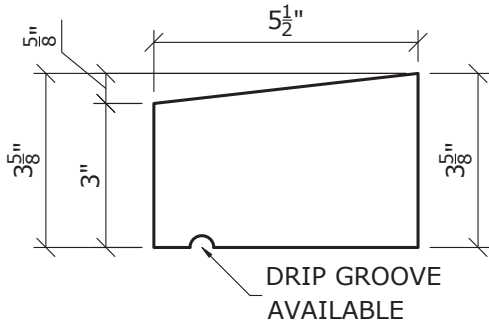

· SECTION ·

**S-1**

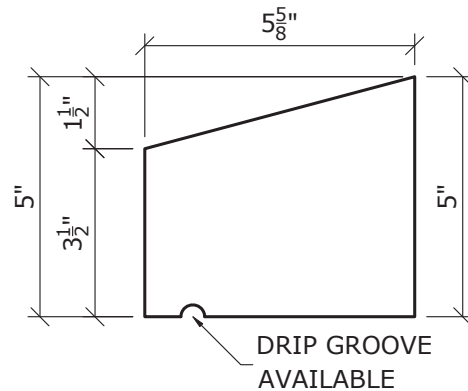

· SECTION ·

**S-4**



1950 RAVINE ROAD  
KALAMAZOO, MI 49004  
PHONE: 269.344.7690  
FAX: 269.344.7693  
<http://www.superiorprecast.com/>

